

Wireless Pushbutton Switches

A2W

World's first*

A “wireless, batteryless”
switch with
“reception confirmation LED”



* Based on November 2017 OMRON investigation.

On-site Innovation Created by a Switch that Connects People and Machines “Wirelessly”

With increasing high-mix low-volume production and more frequent changeovers of products, manufacturing sites increasingly require more versatile and flexible production systems.

OMRON wireless switches offer:

- Production lines without restrictions on the layout
- Easy addition to existing facilities
- Installation on the moving parts

Achieve flexible on-site design with high reliability.
Contribute to enhanced productivity.





DAILY PRODUCTIVITY REPORT				19/09/12
12:44	EOLACT	EOL	VALPTS	PLS/TMR
UPTIME	116	3	108	-11
F.A.L	OFF	EOL	DOUBTS/OK PER	FLT
0	95.0	85	13	WT
0	85.7	111	3	69 88 98



OMRON's unique technologies change the manufacturing.

Self-power generation by the pushing force
BATTERYLESS design eliminates the need for maintenance.

Even in environments with poor visibility or noise
The RECEPTION CONFIRMATION LED provides peace of mind.

Highly diffractive sub-GHz frequency band
ACHIEVES HIGHLY RELIABLE WIRELESS COMMUNICATION.

A Wireless Switch with Reliability and Usability

Patent pending

Reception confirmation LED

Successful reception is confirmed by LED.

Detailed wireless communication status can be monitored.

Reception confirmation LED	Status
Green	Reception success (received field strength "Strong")
Yellow	Reception success (received field strength "Weak")
Red	Reception failure
No lit	Slave button fault (no signal transmission from Slave button)



Degree of protection: IP65

* Only for the main unit of Slave button and optional antenna.

Patent pending

Batteryless due to self-power generation

Self-power generation by the pushing force eliminates battery management.

Operation by the trigger action drives the power generation module and generates stable electricity.

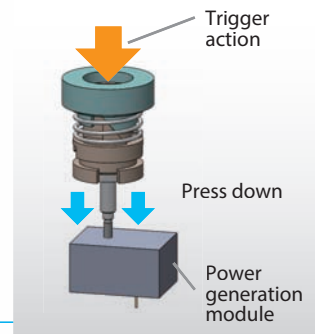

Feel the click firmly even with gloves on

The feel when you click strikes a balance between lower operating force and solid feeling of transmission.

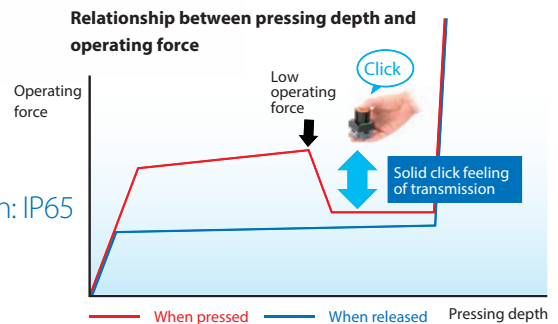

Highly reliable communications

Sub-GHz-band that is less susceptible to obstacles

High diffraction and high penetration



Sub-GHz band (900 MHz)
The radio wave is subject to block by obstacles as it goes straight without diffraction.



Quasi-microwave band (1 GHz to 3 GHz)
The radio wave goes straight without diffraction, being blocked by obstacles.

Long-range transmission

Transmission distance: **approx. 100 m** without obstacles



* Also without influence of noise

Transmission distance: **approx. 30 to 50 m** even with obstacles



Easy Setup and Evaluate with “Wireless Switch Support Tool”, Available for Free

Wireless Switch Support Tool enables easy settings of the master unit and confirmation of radio field intensity transmitted from the slave buttons.

Visualization of master unit settings

You can confirm and change the state of registration, deletion of each slave button.

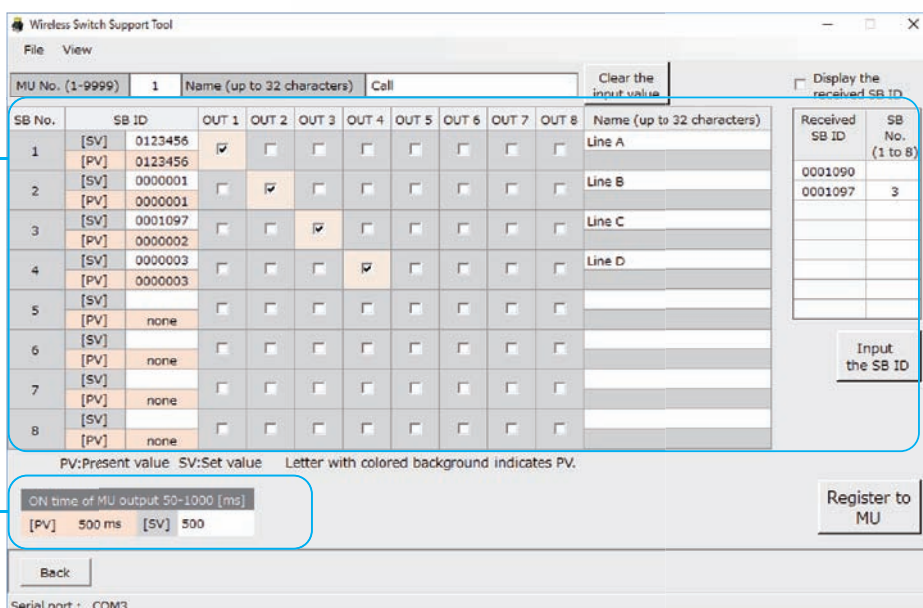

Control output (one-shot) ON duration of master unit is configurable.

Quantitative evaluation of radio wave intensity

Display the radio wave intensity received from slave buttons

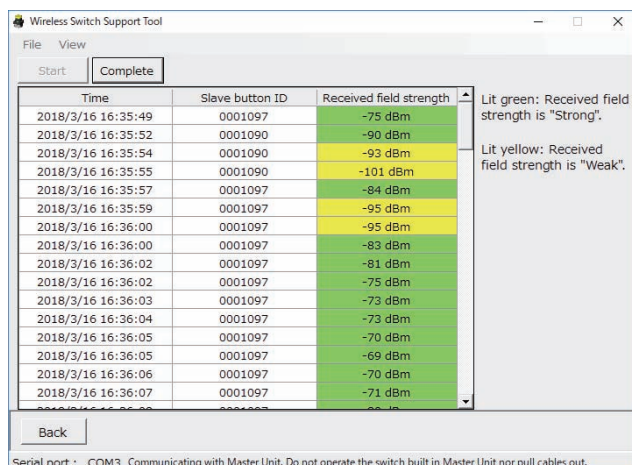

Confirmation of noise intensity surrounding the master unit

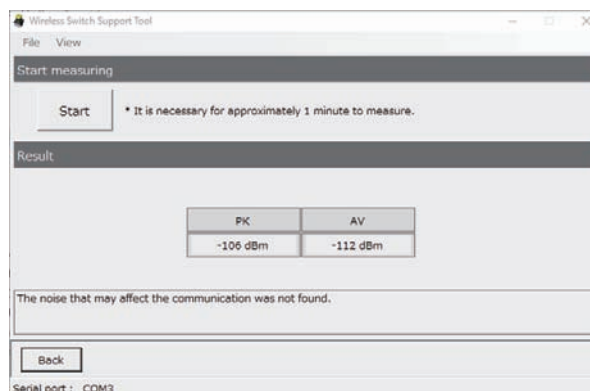

Note: For use of Wireless Switch Support Tool, the USB serial conversion cable (E58-CIFQ2) and the conversion cable (E58-CIFQ2-E) are necessary.

Wireless Communications Enables a Wide Range of Applications.

Wireless communications reduces the troubles caused by disconnection, and time and expenses required for rearrangement of floor layout.

Application for automobile manufacturing processes

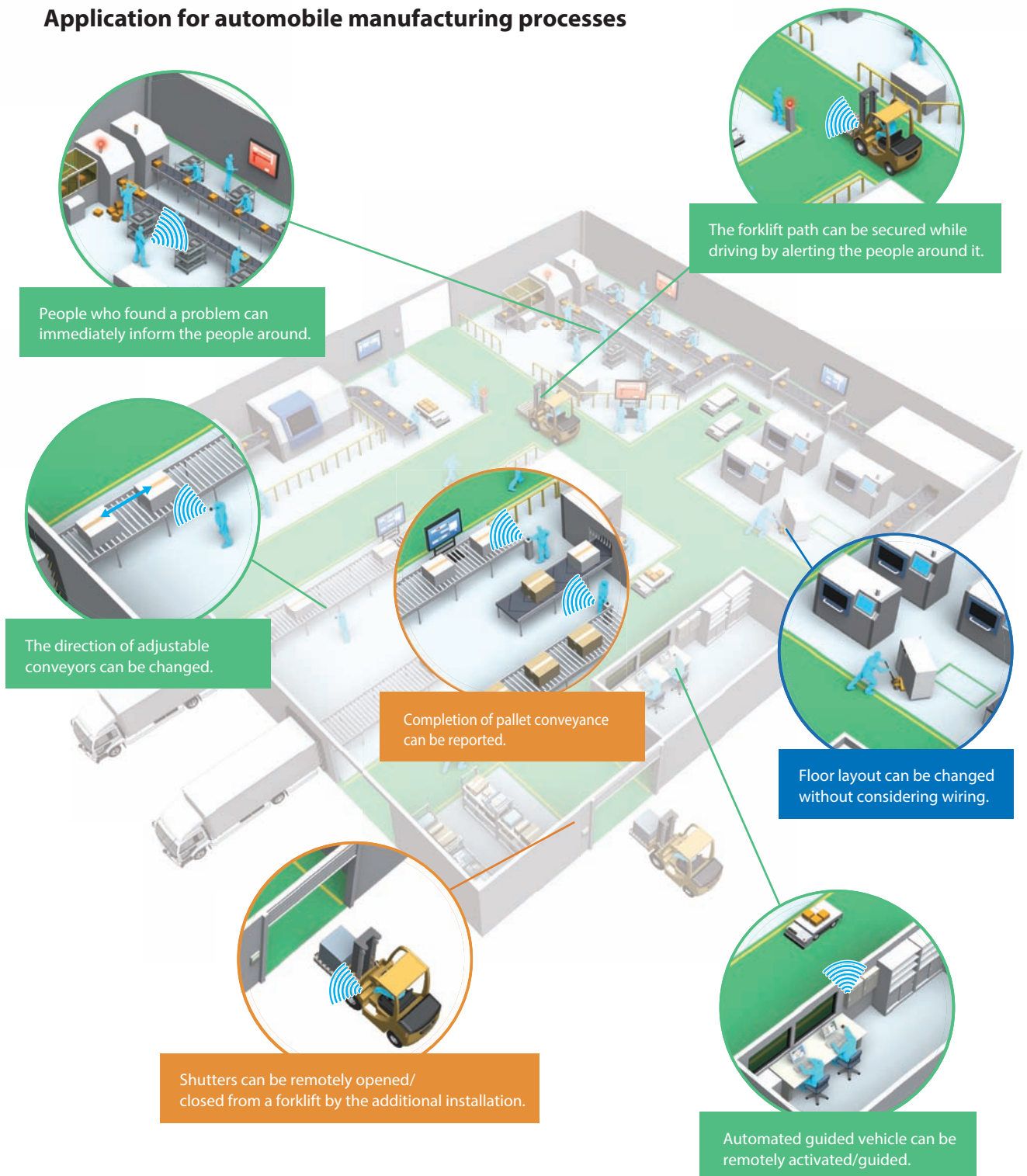

Benefit of wireless 1

Man-hours reduction

Easy to change equipment layout without re-wiring effort

Benefit of wireless 2

Work efficiency improvement

Unfixed slave buttons eliminates location constraints in the work space

Benefit of wireless 3

Conveying work efficiency improvement





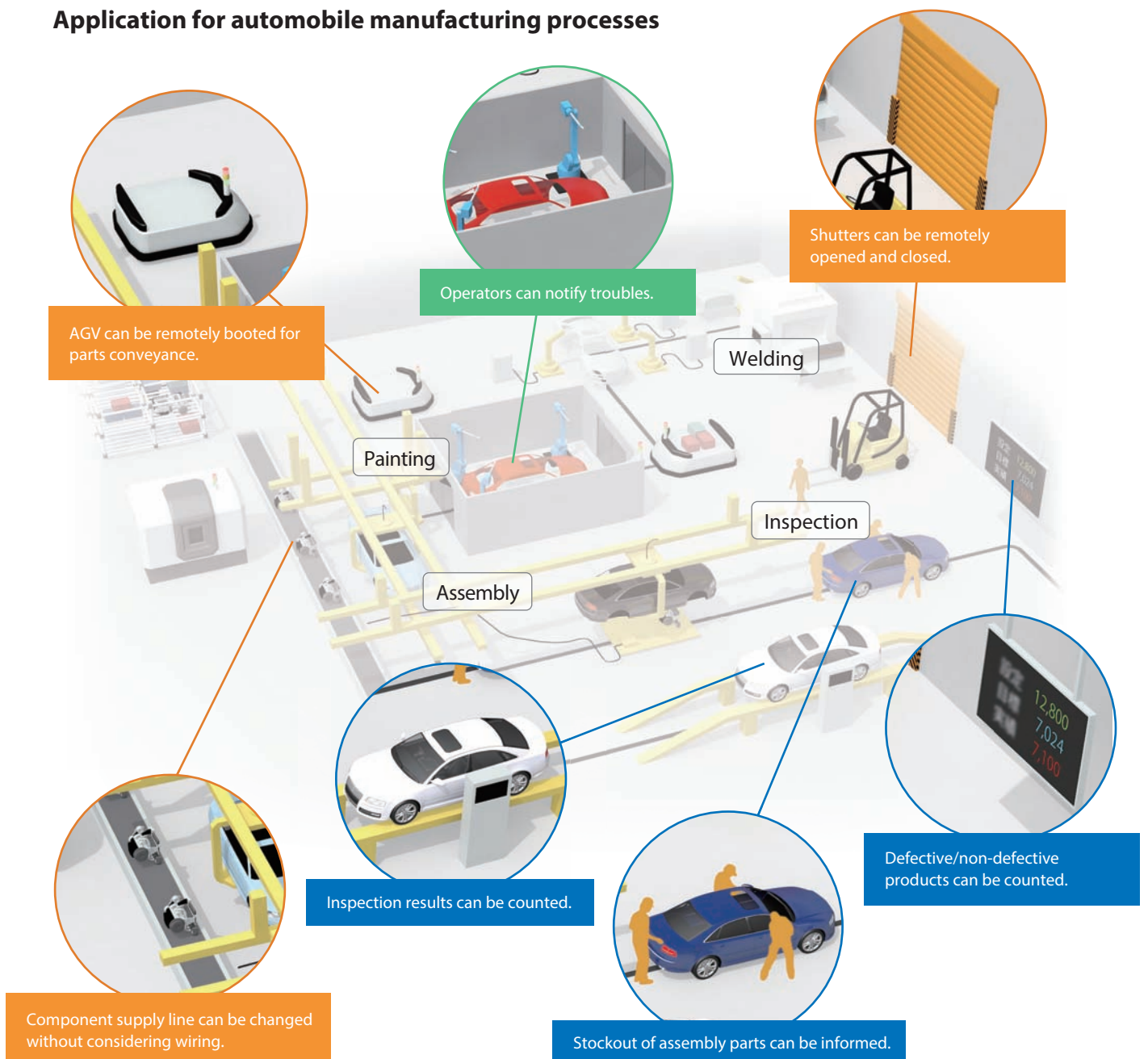



Unfixed slave buttons makes it possible to press buttons without getting in and out of a moving truck

Application for automobile manufacturing processes



Main Specifications

[Slave button]

Button type	Mushroom, Full guard					
Button color	Green 	Yellow 	White 	Blue 	Black 	Red 
Flange color	Yellow 	Black 	Red 			
Degree of protection	IP65					

[Master Unit]

Rated voltage	24 VDC
Allowable voltage range	21.6 to 26.4 VDC
Output circuit shared voltage	30 VDC max.
Maximum load current	50 mA per point
Output logic	One-shot (500 ms)
Number of connected Slave buttons	8 max.

Accessories	Extension antenna (cable length 2.5 m), Slave button strap
-------------	------------------------------------------------------------



Our shared Value Design for Panel (herein after referred to as Value Design) concept for the specifications of products used in control panels will create new value to our customer's control panels.

Combining multiple products that share the Value Design concept will further increase the value provided to control panels.

*Only for Main Units.

Wireless Pushbutton Switch A2W

Wireless switch using sub-GHz band Combines wireless reliability and ease-of-use in consideration of work environments

- Sub-GHz band for reduced interference and better signal propagation to difficult-to-reach areas
- Visualization of impedance to wireless transmission because of damage or noise, using Master Unit error output
- Visualization of Slave button reception status using reception confirmation LEDs
- Transmission distance independent of the transmission position of the Slave button
- Visualization of configuration using PC tools * that avoid erroneous ID registration
- Visualization of signal quality in display and usage environments using PC tools *
- 8 outputs with focus on decentralized control
- Self-power generation eliminates battery replacement and enhances safety and energy saving in the Slave button
- Slave button's shape allows easy use of buttons

* Release planned for April 2018



For the most recent information on models that have been certified for safety standards, refer to your OMRON website.

System Components

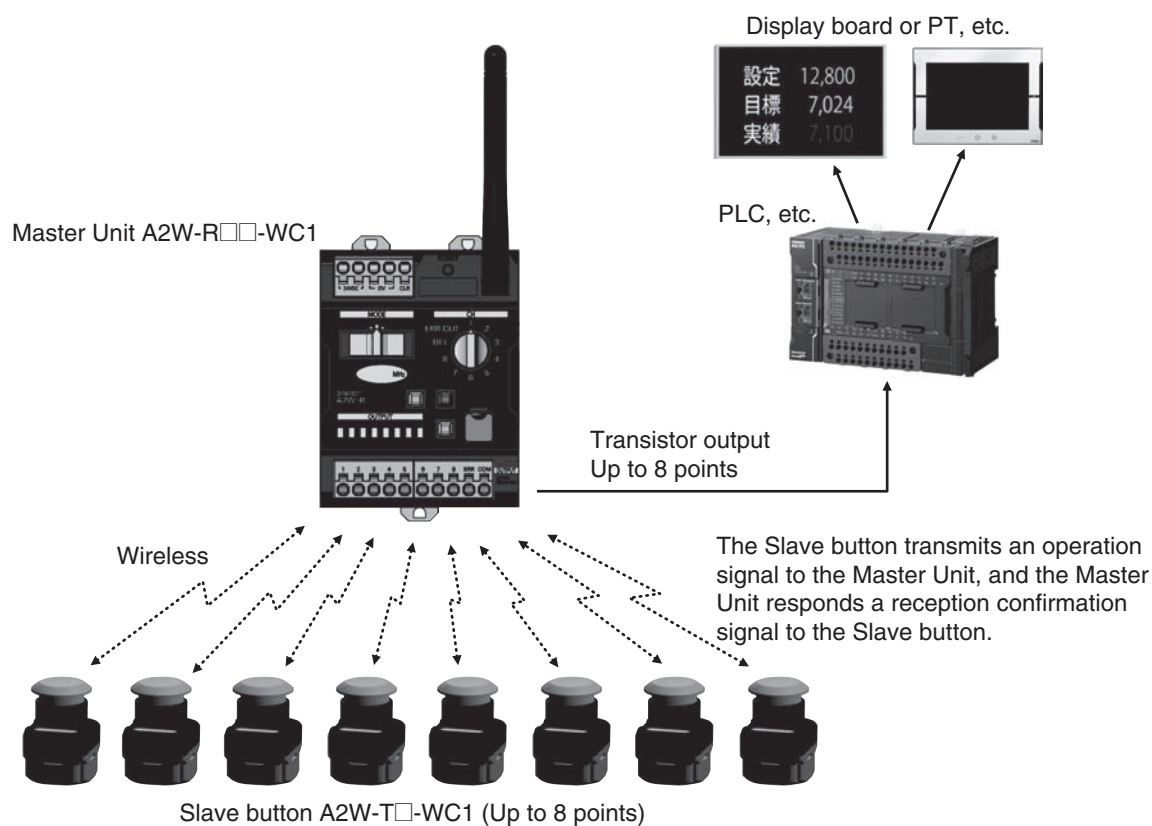

A2W

Model Number Structure

Model Number Structure

Slave button

A 2 W- - WC

1 2 3 4 5 6 7

1.

Slave button	
T	

2.

Frequency (MHz)	
B	868.3

3.

Protocol	
1	OMRON's protocol

4.

Area	
EU	Europe (EU)

5.

Button type	
1	Mushroom
2	Full guard

6.

Button color	
R	Red
G	Green
Y	Yellow
A	Blue
W	White
B	Black

7.

Flange color	
R	Red
Y	Yellow
B	Black

Note: This product is a wireless device that conforms to the radio regulations of Europe (EU).
It cannot be used outside of Europe (EU).
For product details, please contact us separately.

Master Unit

A 2 W- - WC

1 2 3 4 5

1.

Master Unit	
R	

2.

Frequency (MHz)	
B	868.3

3.

Output Configuration	
N	Sinking Outputs
P	Sourcing Outputs

4.

Protocol	
1	OMRON's protocol

5.

Area	
EU	Europe (EU)

Note: This product is a wireless device that conforms to the radio regulations of Europe (EU).
It cannot be used outside of Europe (EU).
For product details, please contact us separately.

Ordering Information

Slave button

Type	Button type	Frequency (MHz)	Area	Button color	Flange color	Model
Slave button	Mushroom	868.3	Europe (EU)	Red	Black	A2W-TB-WC1 EU1RB
			Europe (EU)	Green	Black	A2W-TB-WC1 EU1GB
			Europe (EU)	Yellow	Black	A2W-TB-WC1 EU1YB
			Europe (EU)	Blue	Black	A2W-TB-WC1 EU1AB
			Europe (EU)	White	Black	A2W-TB-WC1 EU1WB
			Europe (EU)	Black	Red	A2W-TB-WC1 EU1BR
	Full guard		Europe (EU)	Black	Yellow	A2W-TB-WC1 EU1BY
			Europe (EU)	Black	Black	A2W-TB-WC1 EU1BB
			Europe (EU)	Red	Black	A2W-TB-WC1 EU2RB
			Europe (EU)	Green	Black	A2W-TB-WC1 EU2GB
			Europe (EU)	Yellow	Black	A2W-TB-WC1 EU2YB
			Europe (EU)	Blue	Black	A2W-TB-WC1 EU2AB
			Europe (EU)	White	Black	A2W-TB-WC1 EU2WB
			Europe (EU)	Black	Red	A2W-TB-WC1 EU2BR
			Europe (EU)	Black	Yellow	A2W-TB-WC1 EU2BY
			Europe (EU)	Black	Black	A2W-TB-WC1 EU2BB

Master Unit

Type	Frequency (MHz)	Area	Output configuration	Model
Master Unit	868.3	Europe (EU)	Sinking Outputs	A2W-RBN-WC1 EU
			Sourcing Outputs	A2W-RBP-WC1 EU

Note: This product is a wireless device that conforms to the radio regulations of Europe (EU).

It cannot be used outside of Europe (EU).

For product details, please contact us separately.

Options (sold separately)

Type	Model	Remarks
High-sensitivity magnetic-base antenna	A2W-AT2.5-WC1	Frequencies: all frequencies supported, cable length 2.5 m Degree of protection: IP65
Slave button holder	A2W-H-WC1	One A2W-H-WC1 is included at purchase of a slave unit.
Slave button strap	A2W-S-WC1	

A2W

Ratings

Wireless Specifications

Item	Slave button model	A2W-TB-WC1 □□□□□
	Master Unit model	A2W-RB□-WC1 □□
Set frequency	868.3 MHz	
Frequency channels	1 channel	
Transmission power	5 mW [e.r.p.] or less	
Wireless service area communications speed	100 kbit/s	
Communications method	Simplex communications	
Number of wireless pushbuttons connected	8 max.	
Communications distance (line of sight)	Approx. 100 m outdoors (with the included pencil antenna)	
Transmission time	Approx. 3 ms (from Slave button transmission to Slave button reception)	
Repeater function	Not supported.	

Applicable Standards

Area	Wireless standards	Safety standards	EMC standards
Europe (EU)	Conforms to EN 300 220-1/-2 Conforms to EN 301 489-1/-3	Conforms to IEC 623680-1 Conforms to EN 62368-1	Conforms to EN 301 489-1 Conforms to EN 301 489-3

Conformance to EN Standards

Use a DC power line less than 3 m to conform to EN standards.

If a power line of 3 m or longer is required, extend the length at the Switching Power Supply's primary side (i.e., the AC power line).

Slave button

Ratings

Item	Specifications
Operating force	25 N max.
Number of operations	1,000,000 operations
Vibration resistance	Frequency: 10 to 55 Hz, half amplitude: 0.75 mm Sweep 5 min, 2 h
Shock resistance	1,000 m/s ² Direction: 3-axis, 6 directions
Ambient operating temperature range	-10 to +55°C (no condensation or freezing)
Ambient operating humidity range	20% to 90%, (no condensation)
Atmosphere	No corrosive gas
Storage temperature range	-40 to +70°C (no condensation or freezing)
Storage humidity range	20% to 90%, (no condensation)
Degree of protection	IP65
Altitude	2,000 m max.
Weight	100 g max.

Reception Confirmation LED

Item	Details
Green	Reception success (received field strength "Strong")
Yellow	Reception success (received field strength "Weak")
Red	Reception failure
Not lit	Slave button fault (no signal transmission from Slave button)

Operating Characteristics

Item	Code	Unit	Initial standard value
Operating force	OF	N	25 N max.
Total travel	TT	mm	6 mm

Master Unit Ratings

Item		Specifications
Master Unit power supply	Rated voltage	24 VDC
	Allowable voltage range	21.6 to 26.4 VDC
	Power consumption	2.4 W max.
	Input current	0.1 A max.
Output rated	Output points	Output 8 points One other point for error output
	Output circuit shared voltage	30 VDC max.
	Maximum load current	50 mA per point
	Leakage current	0.1 mA max.
	Residual voltage	2.0 V max.
	Output logic	One-shot (500 ms)
	Response time	30 ms or less (from Slave button transmission to Master Unit signal output)
Error clear terminal	Number of connected Slave buttons	8 max.
	Residual voltage at short	1.5 V or less, ON
Insulation resistance	Leakage current	0.1 mA or less, OFF (current at short: approx. 7 mA)
		20 M Ω max. (100 VDC) Between the case and power supply terminals and all outputs terminals Between all power supply terminals and all outputs terminals
Dielectric strength		1,000 VAC, 1 min. Between the case and power supply terminals and all outputs terminals Between all power supply terminals and all outputs terminals
		Frequency: 10 to 55 Hz, half amplitude: 0.42mm 3-Directional, 120 minutes each (1 sweep, 1 min. \times 120 sweeps)
Shock resistance		150 m/s ² Direction of shock: 3-axis, 6 directions Shock frequency: 3 \times each direction, total 18
Ambient operating temperature range		-10 to +55°C (no condensation or freezing)
Ambient operating humidity range		20% to 90% (no condensation)
Surrounding atmospheric conditions		No corrosive gas
Ambient storage temperature range		-40 to +70°C (no condensation or freezing)
Ambient operating humidity		20% to 90% (no condensation)
Degree of protection		IP20
Altitude		2,000 m max.
Memory protection		Non-volatile memory (Number of write operations: 1,000,000)
Weight		150 g (not including antenna)
		160 g (including antenna)
Mounting		DIN rail mounting
		Screw mounting

A2W

Parts Names and Functions

Slave button

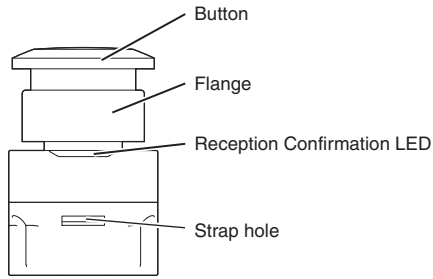

Master Unit

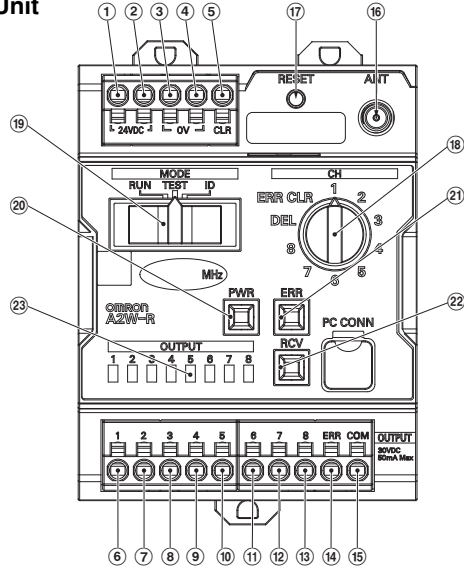

Number	Terminal name	Name	Functions
①	24 VDC	Power supply terminals	Supply 24 VDC.
②	24 VDC		
③	0 V 1		
④	0 V 2		
⑤	CLR	Error clear terminal	Connect the error clear terminal to 0V (GND).
⑥	OUT 1	Output terminals	Connects the output signal line. There are two output types: sinking and sourcing. • A2W-R□N-WC1 □□: Sinking Outputs • A2W-R□P-WC1 □□: Sourcing Outputs
⑦	OUT 2		
⑧	OUT 3		
⑨	OUT 4		
⑩	OUT 5		
⑪	OUT 6		
⑫	OUT 7		
⑬	OUT 8		
⑭	ERR	Error output terminal	Connects the error signal line. There are two output types: sinking and sourcing. • A2W-R□N-WC1 □□: Sinking Outputs • A2W-R□P-WC1 □□: Sourcing Outputs
⑮	COM	Common terminal for outputs	Used as common for output and error output.
⑯	-	Antenna terminal	Connect the included pencil antenna. (Optional antenna A2W-AT2.5-WC1 can also be connected.) It transmits and receives data by wireless communications via the antenna.
⑰	-	Reset switch	<ul style="list-style-type: none"> Delete the Slave button registration information corresponding to the output settings switch. By pressing the output settings switch in the "ERR CLR" state when an error output is generated, error output will be reset. When the power is turned ON in the pressed state, it is reset to the factory setting.

Number	Terminal name	Name	Functions
⑱	-	Output settings switch	Used to register or delete the ID of the Slave button to or from the output of the Master Unit. Also used to reset the error output without using the error clear terminal.
⑲	-	Mode settings switch	Set the operation mode of the Master Unit to ID mode, TEST mode, and RUN mode.
⑳	-	Power LED (PWR)	Lit green when the power is ON.
㉑	-	Error LED (ERR)	Lit red when there is a possibility that abnormality occurs in the master unit and it will not output correctly according to the Slave button operation.
㉒	-	Received field strength LED (RCV)	<ul style="list-style-type: none"> RUN mode or TEST mode It lights according to the received electric field strength of the received data. Lit green: Received field strength is "Strong" Lit red: Received field strength is "Weak" ID mode Lit green when registration or deletion is success. Flashing green when registration or deletion is failure. When error output occurs Lit green when the Master Unit setting data error is detected. Lit yellow when there is a possibility that the Master Unit will not output properly according to the Slave button operation.
㉓	-	Output LED (OUTPUT 1 to 8)	<ul style="list-style-type: none"> RUN mode When outputting to the output terminal, the corresponding output LED lit yellow. TEST mode It does not output to the output terminal, and the corresponding output LED lit yellow. ID mode The output LED corresponding to the output setting switch lit yellow.

Display Section

LED name	Color	Enabled mode	Status	Meaning
PWR	Green	Always enabled	Lit	During Power Supply
			Not lit	No power supplied
RCV	Green or yellow	RUN/TEST	Lit/Not lit	Received field strength monitor: Lit green: Received field strength is "Strong" (lit up for 500 msec) Lit yellow: Received field strength is "Weak" (lit up for 500 msec) Not lit: No received
		ID	Lit/Not lit/ Flashing	ID registration: Lit green: ID registration successful (lit up for 3 s) Not lit: Data for ID registration not received Flashing green: ID registration failed (flashes for 3 s after every 250 ms)
				Delete ID: Lit green: ID deletion successful (lit up for 3 s) Not lit: Data for ID deletion not received Flashing green: ID deletion failed (flashes for 3 s after every 250 ms)
Enabled only when ERR LED is lit	Lit/Not lit	Lit green: Error in Master Unit setting data Lit yellow: Error in the most important function (wireless received, registration/verification, or output) All not lit: Error in CPU initialization process during startup		
OUTPUT 1 to 8	Yellow	RUN/TEST	Lit	Data is received from the ID assigned to the corresponding output
			Not lit	Data is not received from the ID assigned to the corresponding output
		ID	Lit	Reads corresponding output settings switch values 1 to 8
			All Lit	Reads output settings switch value DEL
			All not lit	Reads output settings switch value ERR_CLR
ERR	Red	Always enabled	Lit	Error in CPU initialization processing at startup, or in Master Unit setting data, or in the most important function (wireless received, registration/verification, or output)
			Not lit	No Master Unit error

Note: For received field strength LED (RCV) green flashing, this also flashes even when attempting to select or reset a non-registered output settings No. and delete or reset.

Settings Switch

Mode Settings Switch

Set the operation mode of the Master Unit.

Factory setting: ID

Operation mode	Function
RUN	Communications mode: carry out normal communications
TEST	Test mode: Perform installation test such as reception intensity measurement *
ID	ID mode: Register or delete Slave buttons

* There is no output from the output terminal.

Output Settings Switch

Register or delete the Slave button ID * for each output number of the Master Unit.

Factory setting: 1

No.	Enabled mode	Other settings requirements	Function
1 to 8	ID	Continuous data reception within a fixed period from the Slave button to be registered	Register the ID of the target Slave button to be registered in the specified output number
		Press the Reset switch (ON)	Delete IDs of all Slave buttons registered in the specified output number
DEL	ID	Continuous data reception within a fixed period from the Slave button for which the registration is to be deleted	Delete the ID of the Slave button to be deleted from the registration list
		Press the Reset switch (ON)	Delete all IDs from the registration list
ERR CLR	ERR LED lit red + RCV LED lit yellow	Press the Reset switch (ON)	Execute the software reset of the Master Unit

* This is the identification number of the Slave button for wireless communications.

Reset Switch

Execute resets of Master Unit.

Factory Setting: Not pressed (OFF)

Setting Procedures

Slave buttons Registration Setting

- Set the output for the Slave button ID.
- When the mode settings switch has been set to "ID", the Slave button ID that has received the data during the same operation of the Slave button three or more times within three seconds, and the contents set in the output settings switch are linked.
- If you make "Wireless Push Buttons Registration setting" while another system is operating in the vicinity, erroneous settings may be made. Therefore, make the "Wireless Push Buttons Registration setting" in an environment in which other systems are not operating.
- In the ID deletion procedure, if the received field strength LED (RCV) flashes, then a non-registered port ID may be selected.
- At Slave button registration (ID registration/deletion procedures), confirm that the output LCD is lighting correctly for the output setting No. to select.

Wireless push button registration/deletion procedure

* Using the wireless push button

- Set the mode settings switch of the Master Unit to "ID".
- Set the output settings switch of the Master Unit.
1 to 8: The output destination is set as outputs 1 to 8.
DEL: The information about the received ID is deleted from the registration list.
- Press the wireless push button three or more times to make sure that the received field strength LED (RCV) is lit.
- Set the mode settings switch of the Master Unit to "RUN" or "TEST".

Wireless push button deletion procedure

* Using the RESET switch

- Set the mode settings switch of the Master Unit to "ID".
- Set the output settings switch of the Master Unit.
1 to 8: The ID information registered in outputs 1 to 8 is deleted.
DEL: The information about all IDs is deleted from the registration list.
- Press the Reset switch of the Master Unit until the received field strength LED (RCV) is lit.
- Set the mode settings switch of the Master Unit to "RUN" or "TEST".

Resetting Error Output (RCV indicator lit yellow.)

Using the RESET switch

- Set the output settings switch of the Master Unit to "ERR_CLR".
- Press the Reset switch.

Using the error clear terminal

- Connect the error clear terminal to GND.

A2W

Dimensions

(Unit: mm)

Unit

Slave button

A2W-T□-WC1 □□1□□

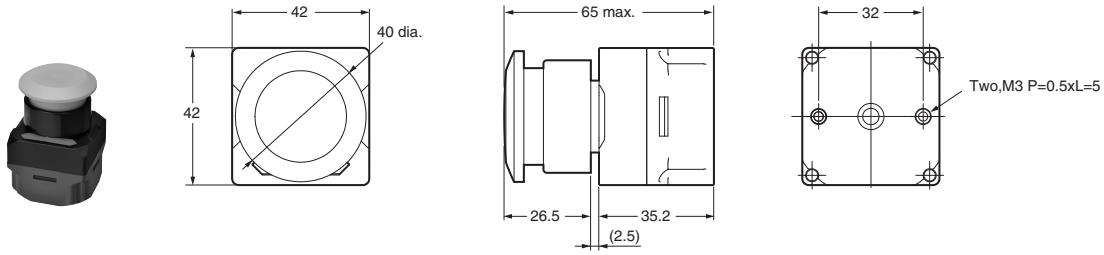

A2W-T□-WC1 □□2□□

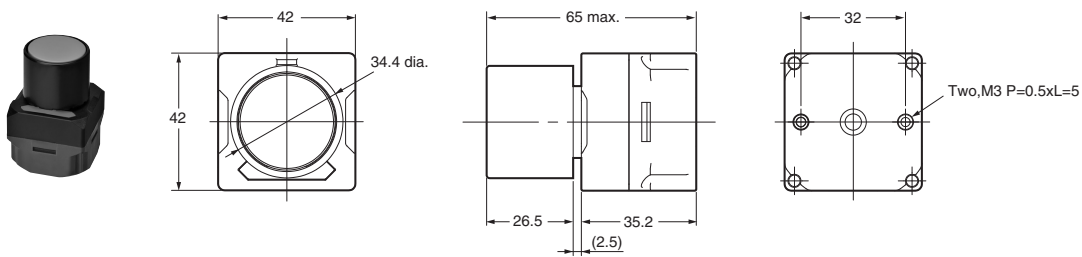

Master Unit

A2W-R□□-WC1 □□

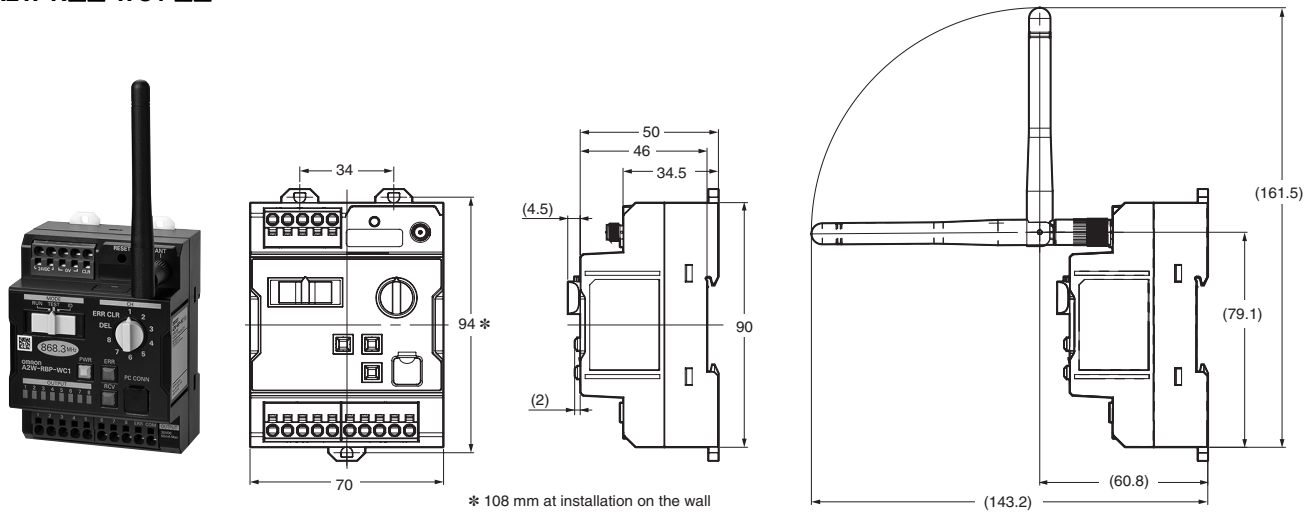

* 108 mm at installation on the wall

Options (sold separately)

Holder
A2W-H-WC1

One A2W-H-WC1 is included at purchase of a Slave button.

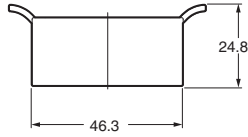
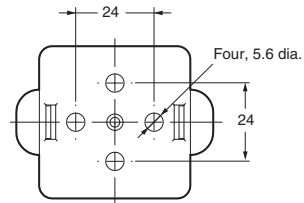
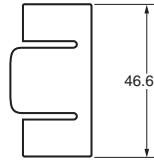
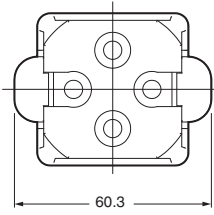

Mounting Hole Dimensions

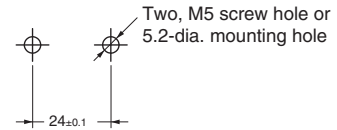

How the holder is used



Strap
A2W-S-WC1

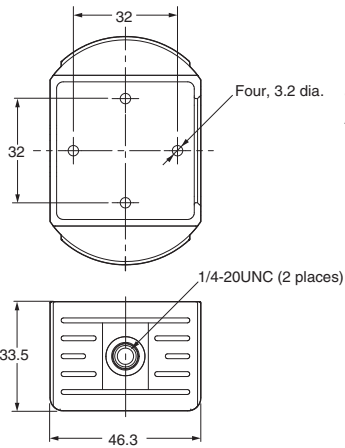

Slave button mounting screws:
Accessories (2 places)
Be sure to use the accessory screws.

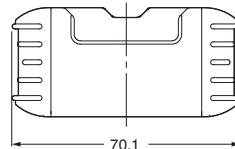

Example of using the strap

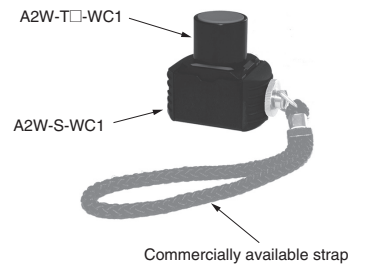

High-sensitivity Magnetic Base Antenna
A2W-AT2.5-WC1

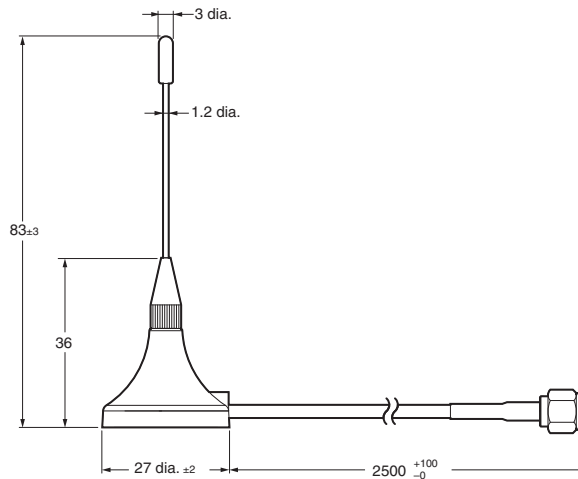

Connection

Internal Connection Diagram (Master Unit)

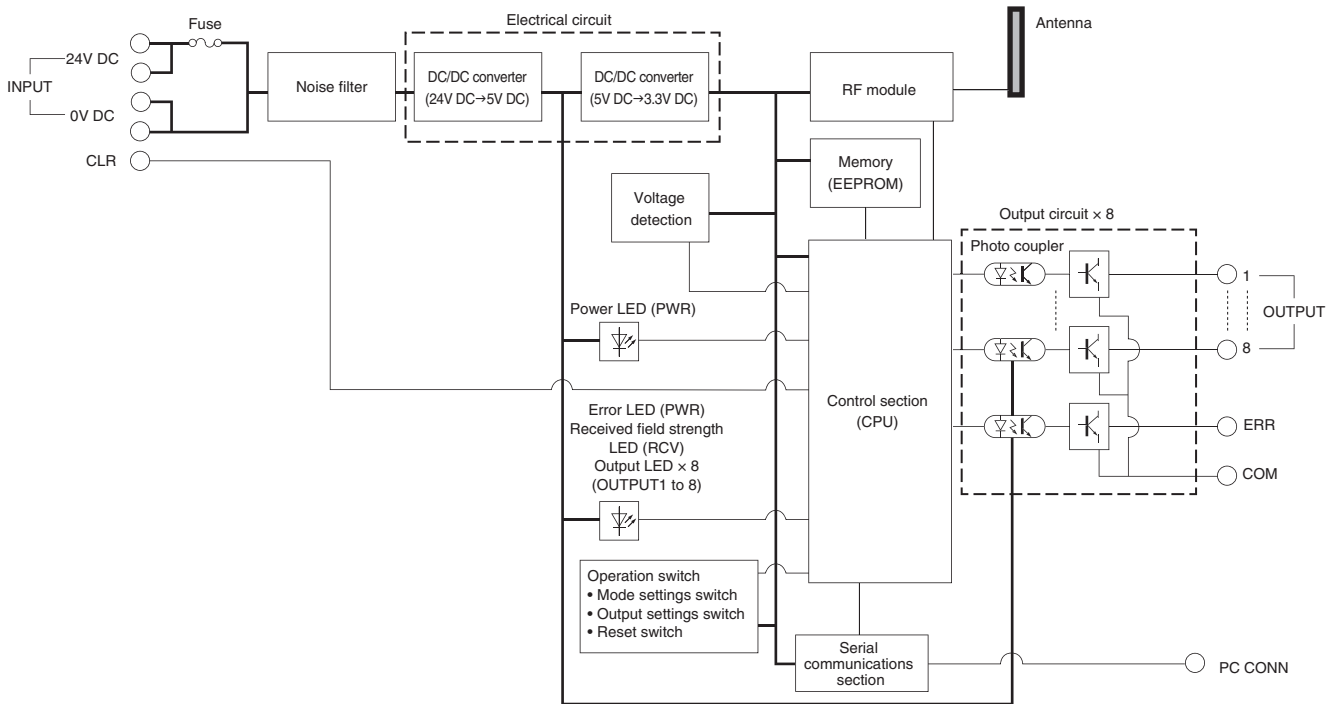

Output Specifications

Operation Timing Chart

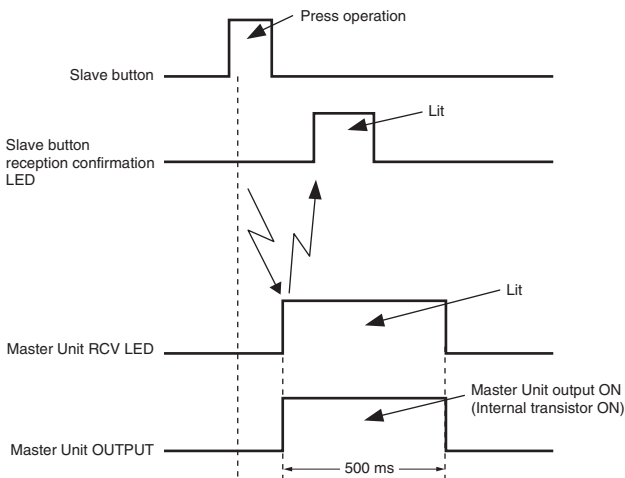

Note: If you press two or more Slave buttons simultaneously within 2 ms, operation of the Slave button after that may not be sent to the Master Unit.

Error Output Signal (Master Unit)

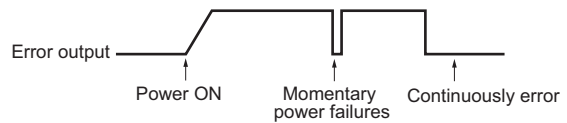

Status	Internal transistor
Power is OFF.	OFF
Normal operation	ON
Error, or momentary power failure	OFF

Output/Error Output Circuit Diagram (Master Unit)

Output/Error output circuits diagram (Sinking Outputs)

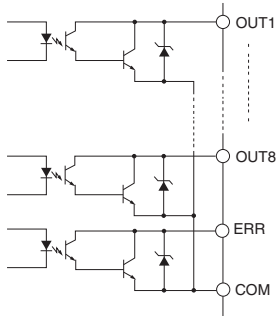

Output/Error output circuits diagram (Sourcing Outputs)

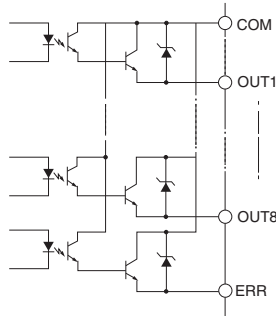

Recommended Ferrules and Crimp Tools Coating peeling amount

Recommend Wire Type		Stripping length (Ferrules not used)				
0.25 to 1.5 mm ² /AWG 24 to AWG 16		8 mm				
2 to 2.5 mm ² /AWG 14		10 mm				
Applicable wire		Ferrule conductor length (mm)	Stripping length (mm) (Ferrules not used)	Recommended ferrules		
(mm ²)	(AWG)			Manufactured by Phoenix Contact	Manufactured by Wago	Manufactured by Weidmuller
0.25	24	8	10	Al 0, 25-8	H0.25/12	216-301
		10	12	Al 0, 25-10	---	---
0.34	22	8	10	Al 0, 34-8	H0.34/12	216-302
		10	12	Al 0, 34-10	---	---
0.5	20	8	10	Al 0, 5-8	H0.5/14	216-201
		10	12	Al 0, 5-10	H0.5/16	216-241
0.75	18	8	10	Al 0, 75-8	H0.75/14	216-202
		10	12	Al 0, 75-10	H0.75/16	216-242
1/1.25	18/17	8	10	Al 1-8	H1.0/14	216-203
		10	12	Al 1-10	H1.0/16	216-243
1.25/1.5	17/16	8	10	Al 1, 5-8	H1.5/14	216-204
		10	12	Al 1, 5-10	H1.5/16	216-244
2.5	14	10	12	Al 2,5-10	H2.5/16DS	216-246
Recommended Crimp Tools				CRIMPFOX6 CRIMPFOX6T-F CRIMPFOX10S	PZ6 roto	Variocrim p4

- Note: 1.** Make sure that the outer diameter of the wire coating is smaller than the inner diameter of the insulation sleeve of the recommended ferrule.
- 2.** Make sure that the ferrule processing dimensions conform to the following figures.

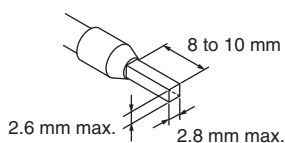

Recommended Flat-Blade Screwdrivers

Use a flat-blade screwdriver to connect and remove wires.

Use one of the following flat-blade screwdrivers.

The following table shows manufacturers and models as of 2018/Dec.

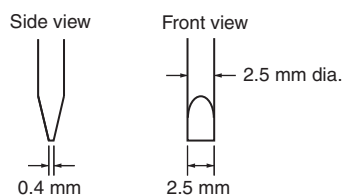

Model	Manufacture
ESD 0,40 × 2,5	Wera
SZS 0,4 × 2,5 SZF 0-0,4 × 2,5 *	Phoenix Contact
0.4 × 2.5 × 75 302	Wiha
AEF.2,5 × 75	Facom
210-719	Wago
SDIS 0.4 × 2.5 × 75	Weidmuller
9900 (-2.5 × 75)	Vessel

* The SZF 0-0,4 × 2,5 (manufactured by Phoenix Contact) can be procured through an OMRON exclusive purchase form (XW4Z-00B).

Using the Magnetic-base Antenna

High-sensitivity Magnetic-base Antenna (A2W-AT2.5-WC1) of the option (sold separately) should be used when the radio environment is not good.

Note: Do not install a product with a pencil-type antenna in a metal panel as it may result in degradation of radio performance. When installing the Master Unit inside a panel, use a high-sensitivity magnetic-base antenna, and make sure the antenna can be installed outside the panel.

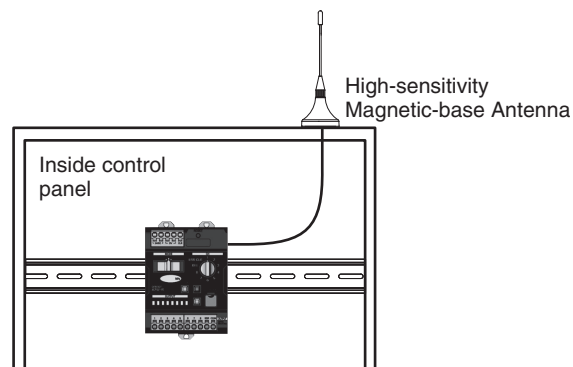

High-sensitivity
Magnetic-base Antenna

Inside control
panel

Terms and Conditions Agreement

Read and understand this catalog.

Please read and understand this catalog before purchasing the products. Please consult your OMRON representative if you have any questions or comments.

Warranties.

- (a) Exclusive Warranty. Omron's exclusive warranty is that the Products will be free from defects in materials and workmanship for a period of twelve months from the date of sale by Omron (or such other period expressed in writing by Omron). Omron disclaims all other warranties, express or implied.
- (b) Limitations. OMRON MAKES NO WARRANTY OR REPRESENTATION, EXPRESS OR IMPLIED, ABOUT NON-INFRINGEMENT, MERCHANTABILITY OR FITNESS FOR A PARTICULAR PURPOSE OF THE PRODUCTS. BUYER ACKNOWLEDGES THAT IT ALONE HAS DETERMINED THAT THE PRODUCTS WILL SUITABLY MEET THE REQUIREMENTS OF THEIR INTENDED USE.

Omron further disclaims all warranties and responsibility of any type for claims or expenses based on infringement by the Products or otherwise of any intellectual property right. (c) Buyer Remedy. Omron's sole obligation hereunder shall be, at Omron's election, to (i) replace (in the form originally shipped with Buyer responsible for labor charges for removal or replacement thereof) the non-complying Product, (ii) repair the non-complying Product, or (iii) repay or credit Buyer an amount equal to the purchase price of the non-complying Product; provided that in no event shall Omron be responsible for warranty, repair, indemnity or any other claims or expenses regarding the Products unless Omron's analysis confirms that the Products were properly handled, stored, installed and maintained and not subject to contamination, abuse, misuse or inappropriate modification. Return of any Products by Buyer must be approved in writing by Omron before shipment. Omron Companies shall not be liable for the suitability or unsuitability or the results from the use of Products in combination with any electrical or electronic components, circuits, system assemblies or any other materials or substances or environments. Any advice, recommendations or information given orally or in writing, are not to be construed as an amendment or addition to the above warranty.

See <http://www.omron.com/global/> or contact your Omron representative for published information.

Limitation on Liability; Etc.

OMRON COMPANIES SHALL NOT BE LIABLE FOR SPECIAL, INDIRECT, INCIDENTAL, OR CONSEQUENTIAL DAMAGES, LOSS OF PROFITS OR PRODUCTION OR COMMERCIAL LOSS IN ANY WAY CONNECTED WITH THE PRODUCTS, WHETHER SUCH CLAIM IS BASED IN CONTRACT, WARRANTY, NEGLIGENCE OR STRICT LIABILITY.

Further, in no event shall liability of Omron Companies exceed the individual price of the Product on which liability is asserted.

Suitability of Use.

Omron Companies shall not be responsible for conformity with any standards, codes or regulations which apply to the combination of the Product in the Buyer's application or use of the Product. At Buyer's request, Omron will provide applicable third party certification documents identifying ratings and limitations of use which apply to the Product. This information by itself is not sufficient for a complete determination of the suitability of the Product in combination with the end product, machine, system, or other application or use. Buyer shall be solely responsible for determining appropriateness of the particular Product with respect to Buyer's application, product or system. Buyer shall take application responsibility in all cases.

NEVER USE THE PRODUCT FOR AN APPLICATION INVOLVING SERIOUS RISK TO LIFE OR PROPERTY OR IN LARGE QUANTITIES WITHOUT ENSURING THAT THE SYSTEM AS A WHOLE HAS BEEN DESIGNED TO ADDRESS THE RISKS, AND THAT THE OMRON PRODUCT(S) IS PROPERLY RATED AND INSTALLED FOR THE INTENDED USE WITHIN THE OVERALL EQUIPMENT OR SYSTEM.

Programmable Products.

Omron Companies shall not be responsible for the user's programming of a programmable Product, or any consequence thereof.

Performance Data.

Data presented in Omron Company websites, catalogs and other materials is provided as a guide for the user in determining suitability and does not constitute a warranty. It may represent the result of Omron's test conditions, and the user must correlate it to actual application requirements. Actual performance is subject to the Omron's Warranty and Limitations of Liability.

Change in Specifications.

Product specifications and accessories may be changed at any time based on improvements and other reasons. It is our practice to change part numbers when published ratings or features are changed, or when significant construction changes are made. However, some specifications of the Product may be changed without any notice. When in doubt, special part numbers may be assigned to fix or establish key specifications for your application. Please consult with your Omron's representative at any time to confirm actual specifications of purchased Product.

Errors and Omissions.

Information presented by Omron Companies has been checked and is believed to be accurate; however, no responsibility is assumed for clerical, typographical or proofreading errors or omissions.

OMRON Corporation Industrial Automation Company

Kyoto, JAPAN

Contact: www.ia.omron.com

Regional Headquarters

OMRON EUROPE B.V.

Wegalaan 67-69, 2132 JD Hoofddorp
The Netherlands

Tel: (31)2356-81-300/Fax: (31)2356-81-388

OMRON SCIENTIFIC TECHNOLOGIES INC.

6550 Dumbarton Circle Fremont
CA 94555 U.S.A.

Tel: (1) 510-608-3400/Fax: (1) 510-744-1442

OMRON ASIA PACIFIC PTE. LTD.

No. 438A Alexandra Road # 05-05/08 (Lobby 2),
Alexandra Technopark,
Singapore 119967

Tel: (65) 6835-3011/Fax: (65) 6835-2711

OMRON (CHINA) CO., LTD.

Room 2211, Bank of China Tower,
200 Yin Cheng Zhong Road,
PuDong New Area, Shanghai, 200120, China

Tel: (86) 21-5037-2222/Fax: (86) 21-5037-2200

Authorized Distributor:

© OMRON Corporation 2018-2020 All Rights Reserved.
In the interest of product improvement,
specifications are subject to change without notice.

CSM_1_3

Cat. No. A270-E1-03

1120(0118)